



DIANCOLLECTION 2022

DIVERSAMENTE ABILI
E TERZA ETÀ'



DIANCOLLECTION 2022

DIVERSAMENTE ABILI
E TERZA ETÀ'

dianflex.com

info@dianflex.com

109-C03121



SET DOCCIA CON SUPPORTO E FLESSIBILE DA CM 125 PALOMA

Composto da: doccetta a pulsante, supporto fisso e flessibile cm 125



109-C03121



Cromo



1



BOSSINI
HIGH QUALITY SHOWER SYSTEMS

accessori bagno per disabili

111-270



MANIGLIONE 30 PER DISABILI

Maniglione in acciaio inossidabile (Euronorm 18 10) resistente a tutti gli ambienti. Garanzia per il bagno per accessori costantemente a contatto con acqua. Fissaggio a parete con tre viti per lato. ARTICOLI PER DISABILI SENZA NORMATIVE.

111-270	Bianco cm. 34 x 4 x 7,5	6
111-270-CR	Cromo cm. 34 x 4 x 7,5	6



111-271



MANIGLIONE 45° PER DISABILI

Maniglione in acciaio inossidabile (Euronorm 18 10) resistente a tutti gli ambienti. Garanzia per il bagno per accessori costantemente a contatto con acqua. Fissaggio a parete con 3 viti per lato. ARTICOLI PER DISABILI SENZA NORMATIVE.

111-271	Bianco cm. 41 x 21,5 x 7,5	6
111-271-CR	Cromo cm. 41 x 21,5 x 7,5	6



111-272



MANIGLIONE 56 BIANCO PER DISABILI

Maniglione in acciaio inossidabile (Euronorm 18 10) resistente a tutti gli ambienti. Garanzia per il bagno per accessori costantemente a contatto con acqua. Fissaggio a parete con 3 viti per lato. ARTICOLI PER DISABILI SENZA NORMATIVE. Colore Bianco.

111-272	Bianco cm. 61 x 7,5	6



MANIGLIONE DI SICUREZZA SAFE IN ACCIAIO



Maniglione in acciaio. Fissaggio: viti e tasselli non inclusi. Portata massima 150 kg.

Icona	Modello	Descrizione	Quantità
	151-200-B30	Bianco cm. 30	6
	151-200-B60	Bianco cm. 60	6



METAFORM®

151-300

MANIGLIONE DI SICUREZZA MODELLO DIRITTO



Maniglione di sicurezza con fissaggio a muro realizzato in acetalico (materiale plastico ad altissima resistenza) studiato in collaborazione con il Politecnico di Milano per rispondere alle seguenti esigenze: 1) resistenza a carichi sul maniglione di almeno 150 kg, 2) perfetto isolamento elettrico per evitare la trasmissione di correnti vaganti. Vite di fissaggio in acciaio inox.

Icona	Modello	Descrizione	Quantità
	151-300-128	cm. 120	1
	151-300-30	cm. 30	1
	151-300-40	cm. 35	1
	151-300-45	cm. 45	1
	151-300-60	cm. 60	1
	151-300-90	cm. 90	1
	151-300-C030	cm 30 cromo	1
	151-300-C035	cm 35 cromo	1
	151-300-C045	cm 45 cromo	1
	151-300-C060	cm 60 cromo	1
	151-300-C090	cm 90 cromo	1
	151-300-C120	cm 120 cromo	1
	151-300-C180	cm 180 cromo	1



DIANHYDRO®

151-301

MANIGLIONE DI SICUREZZA MODELLO A 45°



Maniglione di sicurezza a 45° con fissaggio a muro realizzato in acetalico (materiale plastico ad altissima resistenza) studiato in collaborazione con il Politecnico di Milano per rispondere alle seguenti esigenze: 1) resistenza a carichi sul maniglione di almeno 150 kg, 2) perfetto isolamento elettrico per evitare la trasmissione di correnti vaganti. Vite di fissaggio in acciaio inox.

Icona	Modello	Descrizione	Quantità
	151-301	cm. 30 x 30	1



DIANHYDRO®

151-302**CORRIMANO AD ANGOLO**

Corrimano ad angolo con fissaggio a muro realizzato in acetalico (materiale plastico ad altissima resistenza) studiato in collaborazione con il Politecnico di Milano per rispondere alle seguenti esigenze: 1) resistenza a carichi sul maniglione di almeno 150 kg, 2) perfetto isolamento elettrico per evitare la trasmissione di correnti vaganti. Vite di fissaggio in acciaio inox.

 151-302	 <i>cm. 75 x 75</i>	 1
---	---	---



**151-3020****MANIGLIONE AD ANGOLO**

Corrimano ad angolo con fissaggio a muro realizzato in acetalico (materiale plastico ad altissima resistenza) studiato in collaborazione con il Politecnico di Milano per rispondere alle seguenti esigenze: 1) resistenza a carichi sul maniglione di almeno 150 kg, 2) perfetto isolamento elettrico per evitare la trasmissione di correnti vaganti. Vite di fissaggio in acciaio inox.

 151-3020-100	 <i>mm. 650 x 1000</i>	 1
--	--	---

**151-303****MANIGLIONE VERTICALE DA PARETE A PAVIMENTO**

Maniglione di sicurezza verticale con fissaggio a muro realizzato in acetalico (materiale plastico ad altissima resistenza) studiato in collaborazione con il Politecnico di Milano per rispondere alle seguenti esigenze: 1) resistenza a carichi sul maniglione di almeno 150 kg, 2) perfetto isolamento elettrico per evitare la trasmissione di correnti vaganti. Vite di fissaggio in acciaio inox.

 151-303-180	 <i>cm. 180</i>	 1
---	---	---



CORRIMANO RIGATO IN PLASTICA



Corrimano lineare rigato in PVC medicale, diam 3,5 cm, completo di piastre di fissaggio e ghiera coprivite in ABS. Isolato elettricamente, il tubo rigato offre un'ottima presa antiscivolo e risulta caldo al tatto.

Icona	Modello	Dimensione	Quantità
	151-304-30	cm. 30	1
	151-304-40	cm. 40	1
	151-304-45	cm. 45	1
	151-304-60	cm. 60	1



151-320

CORRIMANO AD ANGOLO CON MONTANTE A SINISTRA



Corrimano a doppio angolo con fissaggio a muro realizzato in acetalico (materiale plastico ad altissima resistenza) studiato in collaborazione con il Politecnico di Milano per rispondere alle seguenti esigenze: 1) resistenza a carichi sul maniglione di almeno 150 kg, 2) perfetto isolamento elettrico per evitare la trasmissione di correnti vaganti. Vite di fissaggio in acciaio inox.

Icona	Modello	Dimensione	Quantità
	151-320	cm. 70 x 70 x 80 sx	1



151-321

CORRIMANO AD ANGOLO CON MONTANTE A DESTRA



Corrimano a doppio angolo con fissaggio a muro realizzato in acetalico (materiale plastico ad altissima resistenza) studiato in collaborazione con il Politecnico di Milano per rispondere alle seguenti esigenze: 1) resistenza a carichi sul maniglione di almeno 150 kg, 2) perfetto isolamento elettrico per evitare la trasmissione di correnti vaganti. Vite di fissaggio in acciaio inox.

Icona	Modello	Dimensione	Quantità
	151-321	cm. 70 x 70 x 80 dx	1



151-322



CORRIMANO ANGOLARE CON MONTANTE A DESTRA

Corrimano angolare con fissaggio a muro realizzato in acetalico (materiale plastico ad altissima resistenza) studiato in collaborazione con il Politecnico di Milano per rispondere alle seguenti esigenze: 1) resistenza a carichi sul maniglione di almeno 150 kg, 2) perfetto isolamento elettrico per evitare la trasmissione di correnti vaganti. Vite di fissaggio in acciaio inox.

 151-322	 cm. 35 x 65 dx	 1
---	---	---



151-323



CORRIMANO ANGOLARE CON MONTANTE A SINISTRA

Corrimano angolare con fissaggio a muro realizzato in acetalico (materiale plastico ad altissima resistenza) studiato in collaborazione con il Politecnico di Milano per rispondere alle seguenti esigenze: 1) resistenza a carichi sul maniglione di almeno 150 kg, 2) perfetto isolamento elettrico per evitare la trasmissione di correnti vaganti. Vite di fissaggio in acciaio inox.

 151-323	 cm. 35 x 65 sx	 1
---	---	---





151-340

BARRA DI SOSTEGNO RIBALTABILE





Barra di sostegno ribaltabile con dispositivo di bloccaggio in posizione verticale.

 151-340	 cm. 85	 1
151-340-65	cm. 65	1

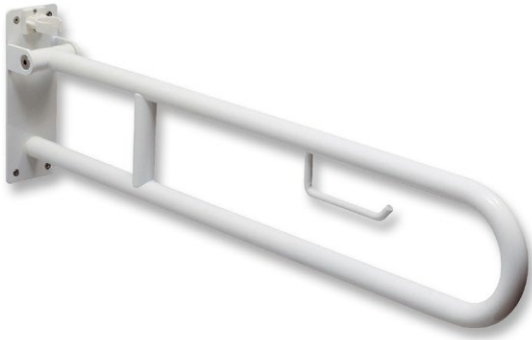

151-3401**BARRA DI SOSTEGNO RIBALTABILE CON
PORTACARTA IGIENICA**

Barra di sostegno ribaltabile, i punti di fissaggio sono realizzati in acciaio inox per garantire la massima resistenza e sicurezza del sistema.

 151-3401	 <i>cm. 85</i>	 1
--	--	---



**151-3402****BARRA DI SOSTEGNO RIBALTABILE MODELLO A
COLONNA**

Barra di sostegno ribaltabile con dispositivo di bloccaggio in posizione verticale; modello a colonna con sistema di fissaggio a pavimento.

 151-3402	 <i>cm. 85</i>	 1
151-3402-65	<i>cm 65</i>	1

**151-3403****DISPOSITIVO DI BLOCCAGGIO PER BARRA DI
SOSTEGNO**

Utile come pezzo di ricambio per le barre di sostegno ribaltabili presenti sul Ns./catalogo nella categoria 1-51 (accessori bagno per disabili).

 151-3403	 -	 1
--	--	---



151-3404

BARRA DI SOSTEGNO RIBALTABILE CON PORTA ROTOLO S.ZA SUPPORTO

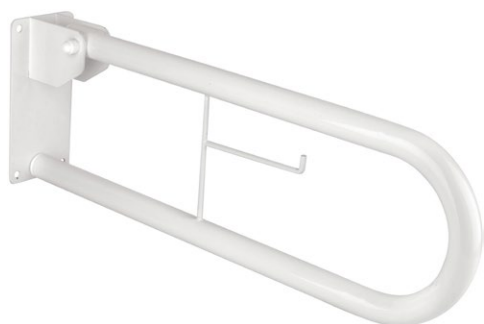

Barra di sostegno ribaltabile, i punti di fissaggio sono realizzati in acciaio inox per garantire la massima resistenza e sicurezza del sistema.

		
151-3404	cm 70	1



151-3405

BRACCIOLI RIBALTABILI DA MURO BIANCHI



Realizzati per offrire un comodo sostegno, vengono utilizzati in abbinamento al sedile ribaltabile da muro. Forniti in coppia, sono dotati di solidi supporti in alluminio pressofuso, ribaltabile verso la parete per ridurre l'ingombro e per agevolarne l'accesso alla seduta; la superficie è in finitura antiscivolo per consentire un sicuro appoggio. I materiali utilizzati, tecnopolimeri, alluminio e acciaio inox, garantiscono massima igiene e una lunga durata. Non richiede manutenzione ed è facile da lavare.

		
151-3405	Lungh. 45 cm	1





151-342

BARRA DI SOSTEGNO CON RINFORZO



SX



Barra di sostegno con rinforzo lunghezza 85 cm, con fissaggio a muro realizzato in acetalico (materiale plastico ad altissima resistenza) studiato in collaborazione con il Politecnico di Milano per rispondere alle seguenti esigenze: 1) resistenza a carichi sul maniglione di almeno 150 kg, 2) perfetto isolamento elettrico per evitare la trasmissione di correnti vaganti. Vite di fissaggio in acciaio inox.

		
151-342-DX	Destro	1
151-342-SX	Sinistro	1





151-343**BARRA DI SOSTEGNO CON RINFORZO CM 65**

Barra di sostegno con fissaggio a muro realizzato in acetilico (materiale plastico ad altissima resistenza) studiato in collaborazione con il Politecnico di Milano per rispondere alle seguenti esigenze: 1) resistenza a carichi sul maniglione di almeno 150 kg, 2) perfetto isolamento elettrico per evitare la trasmissione di correnti vaganti. Vite di fissaggio in acciaio inox.

 151-343-SX	 Sinistro	 1
--	---	---



**151-402****SGABELLO DA BAGNO**

Normative di riferimento: D.M. 236/89 E D.P.R. 503/96. Seduta cm 35x28.

 151-402	 H. 53 cm	 1
---	---	---

**151-403****SGABELLO DA BAGNO IN LEGNO E STRUTTURA IN ACCIAIO CROMATO**

Portata 120 Kg. H. 45 x L 57 - Seduta L 42 x P 26.

 151-403	 -	 1
---	--	---





151-410

SEDILE RIBALTABILE BIANCO



Sedile ribaltabile verniciato Bianco Standard, con fissaggio a muro realizzato in acetalico. Materiale plastico ad altissima resistenza.

 151-410-V	 Verniciato - 475x425x450 mm	 1
---	--	---





151-412

SEDILE PER VASCA BIANCO



Sedile per vasca verniciato Bianco Standard.

 151-412-V	 Verniciato - 670x225x330 mm	 1
---	--	---





151-4121

GOMMINI PER SEDILE VASCA



Gommini di ricambio per nostro articolo 151-412

 151-4121	 -	 1
--	--	---





151-414



SEDILE DA APPENDERE AL MANIGLIONE BIANCO

Sedile da appendere al maniglione verniciato Bianco Standard.

 151-414-V	 Verniciato - 475x425x450 mm	 1
---	--	---





151-500



SPECCHIO RECLINABILE PER DISABILI

Specchio reclinabile realizzato con vetro di sicurezza e struttura portante in acciaio verniciato completo di staffa. Larghezza compreso di pomelli 50 cm.

 151-500	 cm. 45 x 60	 1
---	--	---





151-600

TUBO DIRITTO A DOPPIO INNESTO



Corrimani componibili di colore bianco.

 151-600-09	 900 mm	 1
--	---	---





151-601

**RACCORDO DI CONGIUNZIONE A TEE CON
ATTACCO A MURO**



Corrimani componibili di colore bianco.

 151-601	 -	 1
---	---	---





151-602

**CURVA DI CONGIUNZIONE A 90° CON ATTACCO
A MURO**



Corrimani componibili di colore bianco.

 151-602	 -	 1
---	---	---





151-603

CURVA A 90° CON DOPPIO INNESTO



Corrimani componibili di colore bianco.

 151-603	 -	 1
---	---	---





151-604

TAPPO DI CHIUSURA AD INCASTRO



Corrimani componibili di colore bianco.

 151-604	 -	 1
---	--	---





151-605

GIUNTO PER TUBI



Corrimani componibili di colore bianco.

 151-605	 -	 1
---	--	---





151-800

CIAMBELLA UNIVERSALE RIALZATA H. CM 10 RUBEN



Ciambella rialzata H cm 10, con trattamento antibatterico. Dimensioni: Lunghezza cm 40; Larghezza cm 36,5; Interasse cerniere cm 10. Con sistema di bloccaggio laterale regolabile.

 151-800-B	 Bianca	 1
---	---	---





accessori bagno per disabili

151-801

CIAMBELLA UNIVERSALE RIALZATA CON COPERCHIO VICTOR



Ciambella rialzata H cm 10, con trattamento antibatterico. Dimensioni: Lunghezza cm 40; Larghezza cm 36,5; Interasse cerniere cm 10. Con sistema di bloccaggio laterale regolabile.

 151-801-B	 <i>Bianco</i>	 1
---	--	---





151-804

IDROCASSETTA CON DOCCETTA SHUT-OFF MOD. EUROPA 2



Cassetta di risciacquo multifunzione. Allacciamento idrico laterale del galleggiante. Pulsante doppio scarico. Attacco rubinetto per regolazione di apertura/chiusura del flusso d'acqua e rubinetto per la regolazione della pressione dell'acqua nella doccetta. Accessoriata di portacarta cromato laterale e doccetta shut-off.

 151-804	 -	 1
---	--	---





151-805

SEDILE WC MORBIDO



Dimensioni: Altezza cm 3 x Lunghezza cm 44; Larghezza cm 39. Copriwater morbido anatomico realizzato in XL EXTRALIGHT. Viene rapidamente fissato sulla tavoletta del water, ove rimane stabile e sicuro grazie all'elasticità del materiale e alle alette, interne ed anteriori, di cui è dotato; è adattabile alla maggior parte dei water.



 151-805-B	 <i>Bianco</i>	 1
---	--	---



151-806

ALZAWATER H.12 CON FERMO A VITE CENTRALE E BRACCIOLI FISSI

Alzawater progettato per aiutare chi ha difficoltà a sedersi e ad alzarsi, aumenta l'altezza del water di 12,5 cm; è dotato di braccioli fissi in alluminio anodizzato e rivestiti in neoprene; viene saldamente fissato sul bordo water mediante un apposito meccanismo con staffe posteriori e blocco regolabile a vite anteriore in nylon, adattandosi a tutte le tipologie di water più diffuse. Materiali: HDPE, PA6, neoprene, alluminio.



 151-806-B	 Bianco	 1
---	---	---

**151-900**

PIATTO DOCCIA PER DISABILI FILO PAVIMENTO IN VETRO RESINA CON PILETTA



Piatto doccia per disabili in vetroresina con caratteristica di essere a filo del pavimento quindi con spessore ridotto, completo di piletta di scarico. H. 30 mm

 151-900-70	 70 x 70	 1
151-900-80	80 x 80	1
151-900-90	90 x 90	1

**151-90050**

BOX DOCCIA A SOFFIETTO PER DISABILI

Altezza 185 cm. Box doccia angolare in PVC a due lati e due ante estensibili a soffietto, chiusura calamitata a tutta altezza. Ampio spazio d'entrata grazie all'apertura totale delle ante che si raggruppano sui due lati del box. Soluzione ideale per disabili, in quanto privo di profilo inferiore.

 151-90050-80	 cm 80 x 80	 1
151-90050-90	cm 90 x 90	1



accessori bagno per disabili

151-TR77020

SEDILE RIBALTABILE DOCCIA



In acciaio Inox. Sedile ribaltabile con fissaggio a parete. Dimensioni 35x38 cm

 151-TR77020	 Portata kg 120	 1
---	---	---



151-TR77021

SEDILE DOCCIA CON SCHIENALE



Sedile ribaltabile doccia in acciaio trattato e verniciato con polveri epossidiche. Seduta e schienale in PE-LD antibatterico, facilmente asportabili per le operazioni di pulizia. Carico statico kg. 120 Dimensioni mm. 550x575x475. Colore bianco. Usare viti e tasselli adeguati alle caratteristiche della parete sulla quale verrà installato il prodotto.

 151-TR77021	 -	 1
---	--	---



151-V1018

VASCA PER ANZIANI MODELLO AZZURRA

Vasca fornita con due lati aperti per installazione ad angolo. Per installazione nell'angolo destro acquistare nostro art. 151-V1018-SX. Per installazione nell'angolo sinistro acquistare art. 151-V1018-DX. Per installazione a centro parete acquistare nostro art. 151-V1018-CP, fornita con un solo lato aperto. Dimensioni mm : 1015 x 720 x h 1000. Completa di rubinetto, doccia, 1 maniglione e 1 cuscino poggiatesta. Apertura verso l'esterno. Capacità max acqua 200 litri, altezza scalino ingresso 135 mm, altezza seduta 430 mm. Fornita di flessibili Diam. 1/2" per il collegamento dell'acqua e tubo di scarico 2"; accertarsi che la predisposizione di mandata e scarico ricadano all'interno dell'ingombro vasca.





 151-V1018-CP	 Versione Centro Parete	 1
151-V1018-DX	Versione Dx	1
151-V1018-SX	Versione Sx	1





PANNELLO LATERALE PER VASCA AZZURRA

Pannello per nostro art. 151-V1018. Per installazione a centro parete.

		
151-V1018P	mm 930 x 940 x 20	1





151-V1019



VASCA PER ANZIANI MODELLO DORIS

Vasca fornita con due lati aperti per installazione ad angolo. Per installazione nell'angolo destro acquistare art.151-V1019-SX. Per installazione nell'angolo sinistro acquistare art.151-V1019-DX. Per installazione a centro parete acquistare art. 151-V1019-CP, fornita con un solo lato aperto. Dimensioni mm: 1334 x 673 x h 1016. Completa di rubinetto, doccia, 3 maniglioni e 1 cuscino poggiatesta. Apertura porta verso l'interno e seduta a destra. Capacità max acqua 355 litri, altezza scalino ingresso 100 mm, altezza seduta 450 mm. Fornita di flessibili Diam. 1/2" per il collegamento dell'acqua e tubo di scarico 2"; accertarsi che la predisposizione di mandata e scarico ricadano all'interno dell'ingombro vasca.

		
151-V1019-CP	<i>Versione Centro Parete</i>	1
151-V1019-DX	<i>Pannello lato chiuso a DX</i>	1
151-V1019-SX	<i>Pannello lato chiuso a SX</i>	1





151-V1019P



PANNELLO LATERALE PER VASCA DORIS

Pannello per nostro art. 151-V1019. Per installazione a centro parete.



		
151-V1019P	mm 650 x 975 x 20	1



accessori bagno per disabili

151-V1020



VASCA PER ANZIANI MODELLO LEDA

Vasca fornita con due lati aperti per installazione ad angolo. Per installazione nell'angolo destro acquistare art.151-V1020-SX. Per installazione nell'angolo sinistro acquistare art.151-V1020-DX. Per installazione a centro parete acquistare art. 151-V1020-CP, fornita con un solo lato aperto. Dimensioni mm: 1320 x 762 x h 1143. Completa di rubinetto, doccia, 2 maniglioni e 1 cuscino poggiatesta. Apertura porta verso l'esterno e seduta a destra. Capacità max acqua 348 litri, altezza scalino ingresso 100 mm, altezza seduta 450 mm. Fornita di flessibili Diam. 1/2" per il collegamento dell'acqua e tubo di scarico 2"; accertarsi che la predisposizione di mandata e scarico ricadano all'interno dell'ingombro vasca.

151-V1020-CP	Versione Centro Parete	1
151-V1020-DX	Pannello lato chiuso a DX	1
151-V1020-SX	Pannello lato chiuso a SX	1



151-V1020P

PANNELLO LATERALE PER VASCA MODELLO LEDA



Pannello per nostro art. 151-V1020. Per installazione a centro parete.

151-V1020P	-	1



152-A301

**VASO/BIDET ANZIANI CHIUSO
 COMPLETO DI EROGATORE**



In ceramica.

		152-A301-M	Scarico a Muro	1
		152-A301-P	Scarico a Pavimento	1

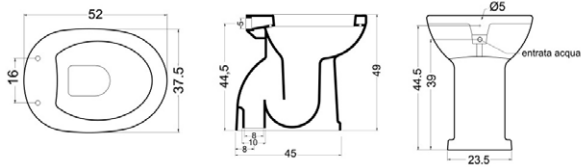

152-A900

SEDILE WC ANZIANI CHIUSO CESAR



Dimensioni: Lunghezza cm 44-49 ; Larghezza cm 36,5 ; Interasse cerniere 10,8 - 21,6; mod. con cerniere regolabili tipo A. Sedile in legno stabilizzato, colato in poliestere. Cerniere in ottone cromato e viti di fissaggio in acciaio inox.

		152-A900	Bianco	1
--	--	----------	--------	---



152-C100

LAVABO DISABILI



Lavabo in ceramica con troppo pieno. Confezione scatola.

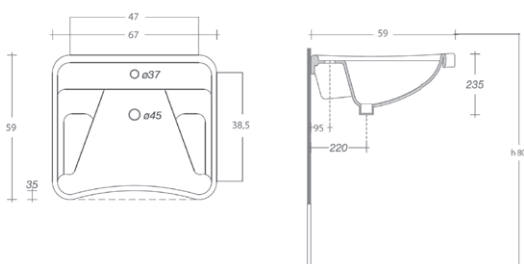

		152-C100-N	Bianco -cm L67 x P59 x H23,5	1
--	--	------------	------------------------------	---



152-C1090

STAFFE MOBILI A MANOPOLA



Da utilizzare sul nostro codice 152-C100

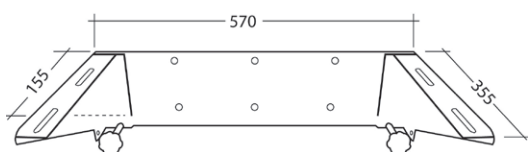

152-C1090	Bianco	1



152-C1091

STAFFE MOBILI A GAS



Da utilizzare sul nostro codice 152-C100

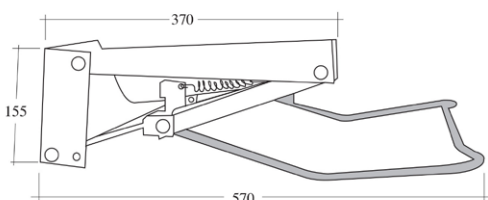

152-C1091	Bianco con supporti cromo	1



152-C300

VASO/BIDET DISABILI COMPLETO DI EROGATORE



Vaso/Bidet in ceramica per ambiente bagno disabili. Confezione scatola.
Coprivaso dedicato nostro articolo 152-D900.

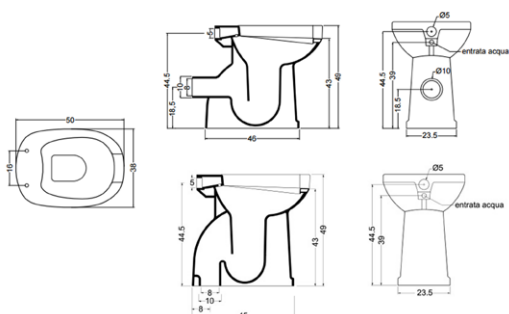

152-C300-M	Scarico a Muro	1
152-C300-P	Scarico a Pavimento	1



152-C400

VASO DISABILI



Vaso in ceramica per ambiente bagno disabili. Confezione scatola.

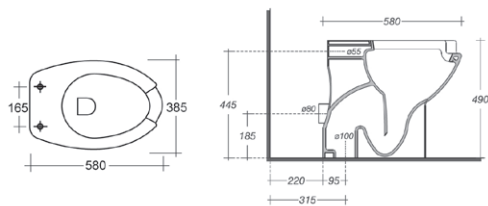

152-C400-M	Scarico a Muro	1
152-C400-P	Scarico a Pavimento	1



152-C412

VASO SOSPESO PER DISABILI APERTURA FRONTALE CM. 56



Vaso in ceramica per ambiente bagno disabili. Confezione scatola.
 Dimensioni: cm 37 x 56. Coprivaso dedicato nostro articolo 152-C901

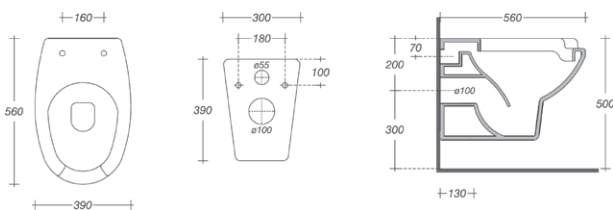

152-C412	Bianco	1



152-C4125

PARETE ATTREZZATA PER DISABILI COMPLETA DI CASSETTA DI SCARICO





Parete in ABS. Telaio interno in acciaio zincato 3mm. Consigliamo di completare la parete con i seguenti nostri articoli: 243-205 (miscelatore termostatico) + 152-C412 (vaso sospeso per disabili cm 56) + 110-162(doccetta shut-off). Bianco.

152-C4125	HxPxL: 119x19,5x53 cm	1





152-C4190**SEDILE WC PER VASO SOSPESO DISABILI LEON**

Dimensioni: Lunghezza cm 53,5; Larghezza cm 36,5; Interasse cerniere cm 18. Mod. con cerniere regolabili tipo A. Sedile in legno stabilizzato, colato in poliestere. Cerniere in ottone cromato e viti di fissaggio in acciaio inox.

		
152-C4190	Bianco	6



**152-C4290****STAFFE FISSE**

Da utilizzare sul nostro codice 152-C100. Lungh. 35,5 cm.

		
152-C4290	Bianco	1

**152-C4390****STAFFE FISSE PER VASO E MONOBLOCCO SOSPESI**

Attacco di fissaggio per wc sospesi disabili cm 80. La staffa è di materiale acciaio zincato spessore 3 mm. Il kit comprende una coppia di staffe, 3 distanziali a 300 mm di interesse, due tiranti doppi, 4 tubetti neri, 4 copridado e tutta la minuteria per assemblare le staffe. La staffa per sanitari sospesi disabili è alta 620 mm profonda 300 mm.

		
152-C4390	-	1



152-C440

VASO E CASSETTA MONOBLOCCO PER DISABILI

Vaso e Cassetta monoblocco in ceramica. Confezione scatola.

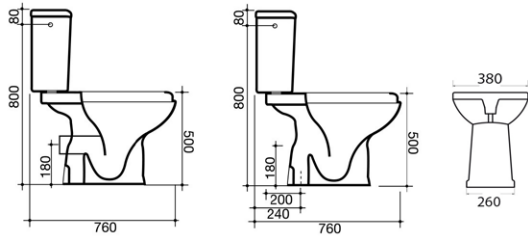

152-C440-M	Scarico a Muro	1
2-C440-P	Scarico a Pavimento	1



152-C5091

**MECCANISMO CASSETTA DISABILI
 MONOBLOCCO**

Meccanismo di scarico per cassetta disabili.



152-C5091	-	1



152-C900

**SEDILO WC LEGNO LACCATO BIANCO
 UNIVERSALE GABRIEL**

Coprivaso universale per tutti i vasi disabili, tranne quelli sospesi. Dimensioni: Lunghezza cm 43,3-46; Larghezza cm 37; Interasse cerniere cm 13,3-18,2. Mod. con cerniere regolabili tipo A. Sedile in legno stabilizzato, colato in poliestere. Cerniere in ottone cromato e viti di fissaggio in acciaio inox.



152-C900	Bianco	1





152-C901

SEDILE WC PER DISABILI UNIVERSALE ROMEO



Sedile da utilizzare su codice articolo 152-C412 e 152-C400. Dimensioni: Lunghezza cm 44-46,5; Larghezza cm 37; Interasse cerniere cm 14-19. Mod. con cerniere regolabili tipo A. Sedile in legno stabilizzato, colato in poliestere. Cerniere in ottone cromato e viti di fissaggio in acciaio inox.

 152-C901	 <i>Bianco</i>	 1
--	--	---



152-C902

SEDILE WC PER DISABILI UNIVERSALE MATTEO

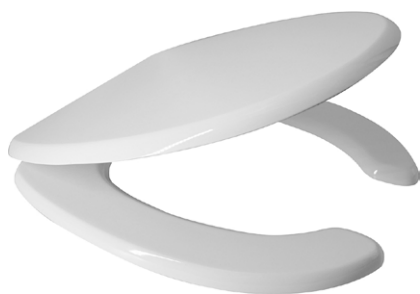

Sedile in legno mdf. Dimensioni: Lunghezza cm 41-46,5; Larghezza cm 37,5; Interasse cerniere cm 10-20,5. Modello con cerniere regolabili tipo A. Cerniere e viti di fissaggio in acciaio inox.

 152-C902	 <i>Bianco - Cerniere A passanti</i>	 1
--	--	---





152-D900

SEDILE WC PER VASO DIVERSAMENTE ABILI



Dimensioni: Lunghezza cm 45-47; Larghezza cm 38; Interasse cerniere cm 14,5-19,5. Mod. con cerniere regolabili tipo A. Sedile in legno stabilizzato, colato in poliestere. Cerniere in ottone cromato e viti di fissaggio in acciaio inox. Idoneo per vaso codice 152-D400.

 152-D900	 <i>Bianco</i>	 1
--	--	---



152-S100

**LAVABO ERGONOMICO MONOFORO
 EVOLUTION**



In ceramica. Colore bianco. Montaggio a muro o sopraiano.

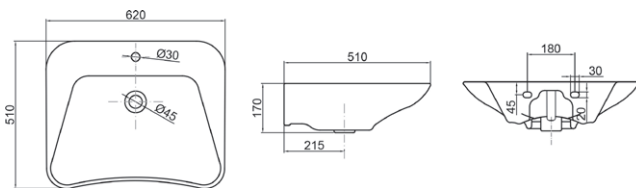

152-S100	L. 62 cm	1
----------	----------	---



152-S300

BIDET FILO MURO SERIE EVOLUTION



In ceramica. Colore bianco. H. 47 cm.

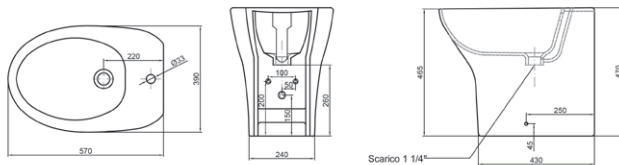

152-S300-R	Erogazione rubinetto	1
------------	----------------------	---



152-S400

VASO FILO MURO SERIE EVOLUTION



In ceramica. Colore bianco. H. 47 cm. Con scarico universale a risparmio idrico 4,5 L.

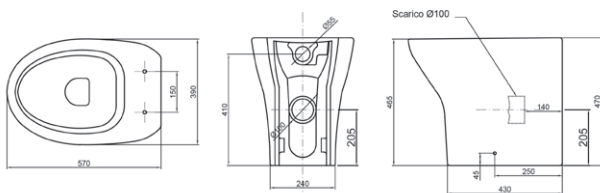

152-S400	-	1
----------	---	---



152-S402



VASO CON APERTURA FRONTALE EVOLUTION

In ceramica. Colore bianco. H. 47 cm. Scarico universale a risparmio idrico 4,5 L.

152-S402	-	1

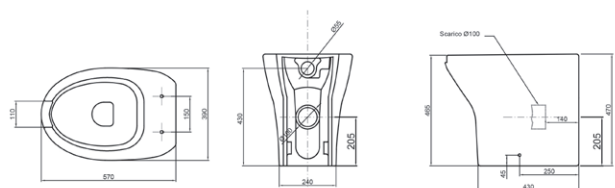

152-S412



VASO SOSPESO CON APERTURA FRONTALE UP

In ceramica. Colore bianco. Montaggio su staffa universale.

152-S412	-	1

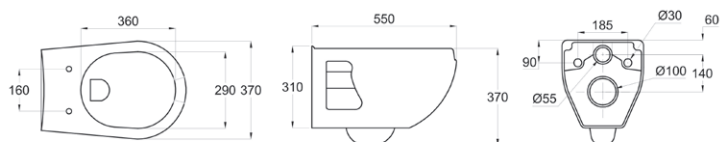

152-S900



SEDILE WC PER VASO EVOLUTION

Sedile in poliestere colato, cerniere inox. Per vaso art. 152-S400. Sedile (Forma tipo 4 - cerniere tipo universali) dedicato a casa ceramica Sanitosco serie Evolution. Dimensioni: Lunghezza cm 48-51; Larghezza cm 39; Interasse cerniere cm 11-19 .

152-S900	-	1





152-S902



SEDILE WC PER VASO EVOLUTION CON APERTURA FRONTALE

Sedile in poliestere colato con apertura frontale, cerniere inox. Per vaso art. 152-S402. Dimensioni: Lunghezza cm 48-51; Larghezza cm 39; Interasse cerniere cm 11-19

 152-S902	 -	 1
--	--	---





152-S912



SEDILE WC PER VASO SOSPESO UP

Sedile in poliestere colato con apertura frontale, cerniere inox tipo A. Per vaso art. 152-S412. Dimensioni: Lunghezza cm 41-42; Larghezza cm 38; Interasse cerniere cm 16,5 .

 152-S912	 -	 1
--	--	---







152-T100

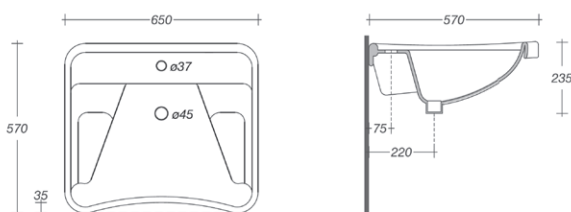

LAVABO PER TERZA ETA'

Lavabo in ceramica bianco con troppo pieno.



 152-T100-N	 -	 1
--	--	---



igienici sanitari in ceramica per disabili e terza eta'

152-T300

BIDET PER TERZA ETA'



In ceramica bianco.

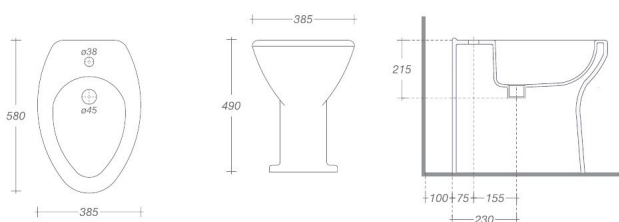

52-T300	-		1



152-T400

VASO PER TERZA ETA'



In ceramica bianco.

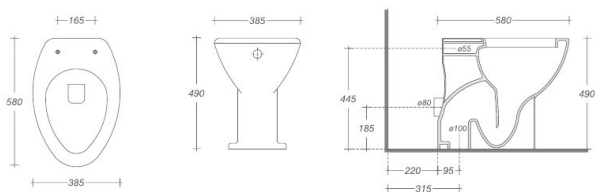

152-T400-M	Scarico a Muro		1
152-T400-P	Scarico a Pavimento		1



152-T900

SEDILE WC PER VASO TERZA ETA'



Dimensioni: Lunghezza cm 47-49; Larghezza cm 37,5; Interasse cerniere 13,5-18,5; cerniere regolabili.

152-T900	Bianco Cerniere C espansione		1
152-T900-33	Bianco - Cerniere A passanti		1





152-T902

SEDILE WC IN ABS PER VASO TERZA ETÀ'



Sedile in ABS per vaso Terza età ns art. 152-T400 (Forma tipo 1- cerniere tipo A) . Dimensioni: Lunghezza cm 48; Larghezza cm 39; Interasse cerniere 12-18; cerniere a barra regolabili.

 152-T902	 <i>Bianco</i>	 1
--	--	---



DIANHYDRO

152-T903

SEDILE WC PER VASO TERZA ETÀ' NEW



Sedile in legno per vaso Terza età ns art. 152-T400 (Forma tipo 4) . Dimensioni: Lunghezza cm 44,5-47; Larghezza cm 37,5; Interasse cerniere 14-19; cerniere regolabili tipo A passanti.

 152-T903	 <i>Bianco Cerniere A passanti</i>	 1
--	--	---



DIANHYDRO

DIANCOLLECTION 2022

DIVERSAMENTE ABILI
E TERZA ETÀ

dianflex.com

info@dianflex.com